



PROSTOR[®]

BY BRUSTOR



2012 - 1

NEW
STRONGEST AWNING
IN THE MARKET
SEE PAGES 16-17

UNIQUE: 3 year guarantee on all awnings

“Innovator in Sun Systems”

Leader in sun protection



The family concern Brustor nv is already 30 years one of the market leaders in the development and manufacturing of box awnings, solar screens and conservatory awnings for houses and commercial property.

Brustor nv will use the trademark Prostor to gather the production of innovative awnings, umbrella systems and accessories for recreation vehicles, static caravans and holiday homes.

The company employs more than 100 highly skilled people, who always go that extra mile. Each and every one of them is an experienced, motivated,

customer oriented individual with a passion for quality. Brustor nv is located at Gellewe, Belgium, at 20 km of Lille and 100 km of Brussels. This central location is a big advantage for fluent logistics. At Brustor nv we manufacture awnings in premises of more than 20,000 m².

Brustor nv invests in the future and recently expanded in Gulleghem, Belgium, with a new production hall of 18,000 m², including a new state-of-the-art powder coating line. Due to this expansion to 38,000 m² in Gulleghem, Belgium, the Group is able to make quality products in all possible colours within the shortest possible delivery time.

Prostor range	NEW 350	600	NEW 450	500	NEW 550
Pages for more info	6-7	8-9	10-11	12-13	14
Wall mounting			lb	lb	lb
Roof mounting	lb	lb			
Length (min.-max.)	2.65 m - 3.75 m	2.60 m - 5.50 m	2.65 m - 4.00 m	1.50 m - 5.50 m	3.00 m - 4.50 m
Projection (max.)	2.50 m	2.50 m or 2.75 m	2.50 m	2.50 m or 2.75 m	2.50 m
Weight (min.-max.)	19 kg - 28 kg	23 kg - 42 kg	17 kg - 24.5 kg	11 kg - 39 kg	23 kg - 32 kg
Aluminium end caps	lb	lb	lb	lb	
Flat bracket supplied as standard			lb	lb	lb
Self-supporting retractable arm					
Support legs in front profile	lb	lb	lb	lb	lb
Standard supplied wall brackets	lb	lb	lb	lb	lb
Locks in front profile		lb		lb	
Fix crank	lb		lb		lb
Telescopic crank		lb		lb	
PVC fabric (no welding seam, in 1 piece, printed from top to bottom)	lb	lb	lb	lb	lb
Acrylic fabric					
Available with 12V motor		lb		lb	
Available with 230V motor		lb		lb	
LED in retractable arm		lb		lb	lb
Camp Room	lb	lb	lb	lb	lb
Sun/Rain Protector Front	lb	lb	lb	lb	lb
Sun/Rain Protector Side	lb	lb	lb	lb	lb

lb Standard lb Optional

Awnings for houses and commercial property



Outdoor Living

PROSTOR PARASOLS

OUTDOOR LIVING

Umbrella Systems

Ask for our other brochures: 'Awnings for houses and commercial property', 'Umbrella Systems' and 'Outdoor Living' or visit our websites www.brustor.com or www.prostor.be



Content

Your advantages in a blink of an eye 4-5

Our top quality features.

Prostor roof awnings 6-9

Retractable arm awnings for roof mounting in various dimensions and colours.

Prostor wall awnings 10-18

Retractable arm awnings for wall mounting in various dimensions and colours.

Brackets 19

Specific brackets for vehicles with different shapes.

Fabric and box colours 20-21

Discover the various colours of awning fabric and box.

Camp Room 22-24

Water- and windproof tent. Easy and fast installation.

Sun/Rain Protector 25

Front and side panels that protect you against sun and/or rain.

Prostor LED 26

Unique LED lighting system, integrated in the awning.

Accessories 27

Awning accessories that optimise your comfort.

Prostor Rollo + 28

Automatic roller blind. Easy to mount on all existing awnings.

750	NEW 802	NEW 900
15	16-17	18
lb	lb	lb
3.00 m - 4.00 m	4.00 m - 6.00 m	4.00 m - 6.00 m
2.50 m	2.75 m	2.75 m
26 kg - 33 kg	43 kg - 57 kg	48 kg - 62 kg
lb	lb	lb
lb	lb	lb
	lb	lb
lb	lb	lb
lb	lb	lb
lb	lb	lb
lb	lb	lb
lb	lb	lb
lb	lb	lb
lb	lb	lb
lb	lb	lb
lb	lb	lb
lb	lb	lb
lb	lb	lb
lb	lb	lb
lb	lb	lb



1 ALUMINIUM END CAPS

The end caps are made of 100% aluminium. Consequently, the Prostor awning is more resistant against shock and impact.



3 SOLID RETRACTABLE ARMS

The extra strong arms and arm supports provide an optimal fabric tension and protection against wind.



2A MANUAL OPERATION

You can operate the ultra rapid and flexible gear with extending telescopic crank.



4 PATENTED LOCKS

The locks on both sides of the front profile assure a perfect closing as well as an extra safety while driving.



2B OPERATE WITH MOTOR

Available with integrated motor (12V or 230V) with manual override for emergency operation.



5 EASY LOCK FLIPPER

The patented Easy Lock Flipper prevents the support legs from dropping.

YOUR ADVANTAGES IN A BLINK OF AN EYE



6

8

9

10

7



6 COMPLETE PRINTED FABRIC

The Prostor top-quality awning fabric in PVC or Acrylic is printed from top to bottom. More information on page 21.



7 ROBUST PROFILES

All our profiles are made out of 100% aluminium. The back profile is even foreseen by a unique cable gutter.



8 TENSION RAFTER

The tension rafter keeps the fabric tight. Supplied as standard for awnings of 4 m and more.



9 LED LIGHT

An unique patented system that is fully integrated in the middle of the awning. More information on page 26.



10 UNIFORM BOX COLOURS

Possibility to powder coat the box in the same colour as the vehicle (see pages 20-21).



11 VARIOUS ACCESSORIES

The Prostor awnings can be equipped by all sorts of accessories. Find out more on pages 22-28.

You can find more specific features or deviations on the pages describing the different awning types. See pages 2-3 and 6-18.



Roof mounting



* No bracket supplied as standard.
For specific brackets see page 19.

Note: the brackets must be installed behind the end caps.

Dimensions (ALWAYS state x, y, zz when ordering)

Item number	Length	Projection	Weight
35x-265-y-zz	2.65 m	2.50 m	19 kg
35x-300-y-zz	3.00 m	2.50 m	21 kg
35x-325-y-zz	3.25 m	2.50 m	23 kg
35x-350-y-zz	3.50 m	2.50 m	25 kg
35x-375-y-zz	3.75 m	2.50 m	28 kg

x: Awning box: 0 = White
1 = Anodised

y: Operation: 0 = Manual

zz: Fabric number: 01 = Jamaica Green
02 = Aruba Blue
03 = Grey Waves
04 = Blue Waves



**25%
SMALLER**



COMPACT DIMENSIONS
The Prostor 350 is the most compact and lightest roof awning in the market, without decreasing the high quality requirements of Prostor.



NEW

NEW ARM AND SUPPORT LEG
The support legs are neatly stored in the lead rail of the awning. They can be easily released with the spring lock.



ALUMINUM END CAP
Like other Prostor awnings, the gearing is protected by a lacquered aluminium end cap. This end cap makes the awning even more impact and shock-proof.



ARM FIXED TO END CAP
The retractable arms are fixed to the robust aluminium end caps, therefore the dimensions of the awning are so compact. The mounting brackets must be placed behind this end cap.



IDEAL FOR CARAVANS AND VANS
The Prostor 350 offers a projection of 2.5m (instead of 2m) for the smallest awning length (2.65m). Its compact dimensions, light weight and this extra shade make the Prostor 350 the ideal awning for caravans and vans.



Roof mounting



MOUNTING VIA BRACKET*

* No bracket supplied as standard. For specific brackets see page 19.

Dimensions (ALWAYS state x, y, zz when ordering)

Item number	Length	Projection	Weight
6x-260-y-zz	2.60 m	2.00 m	23 kg
6x-300-y-zz	3.00 m	2.50 m	27 kg
6x-350-y-zz	3.50 m	2.50 m or 2.75 m	30 kg
6x-375-y-zz	3.75 m	2.50 m or 2.75 m	31 kg
6x-400-y-zz	4.00 m	2.50 m or 2.75 m	33 kg
6x-450-y-zz	4.50 m	2.50 m or 2.75 m	36 kg
6x-500-y-zz	5.00 m	2.50 m	39 kg
6x-550-y-zz	5.50 m	2.50 m	42 kg

x: Awning box: 0 = White
 1 = Anodised
 8 = Special coating (see pages 20-21)

y: Operation: 0 = Manual
 1 = Motor 230V
 2 = Motor 230V - remote control
 4 = Motor 12V

zz: Fabric number: 01 = Jamaica Green
 02 = Aruba Blue
 03 = Grey Waves
 04 = Blue Waves
 05 = White Sand
 06 = Horizon Grey*
 07 = Horizon Blue*



CHARACTERISTICS



ROBUST BUT STILL COMPACT

The robust Prostor 600 is a top quality awning, very strong and stable. By the way, the Prostor 600 is the most compact awning for bigger lengths (4 m and more). By its design the awning perfectly follows the line of your vehicle.



SAME AWNING BOX UP TO 5.50 M

The Prostor 600 has the same awning box for length up to 5.50 m. As a result the weight for larger awnings (from 4 m) decreases significantly.



MOTOR WITH MANUAL OVERRIDE

The motor (220V or 12V) is fully integrated in the roller tube and the emergency manual operation is a standard accessory. The motor can be operated by remote control (230V) or switch (12V or 230V). More information on page 27.



**NEW
PROJECTION
2.75 m**

MORE SHADE

The standard projection is 2.50 m. Optionally, you can have a projection of 2.75 m for awning lengths of 3.5 m; 3.75 m; 4 m and 4.5 m. Only available in fabric colour 06 and 07.



**from 1.40 m
up to 2.40 m**

TELESCOPIC HAND CRANK

You can operate the ultra rapid and flexible gear with the extending hand crank. The hand crank can be easily stored with a standard supplied clip.



SPECIAL DUCATO, JUMPER AND BOXER DESIGN

The Prostor 600 is also available in a length of 3.75 m, the perfect length for these types of vehicle. The fitting must be done with specific brackets (see page 19).

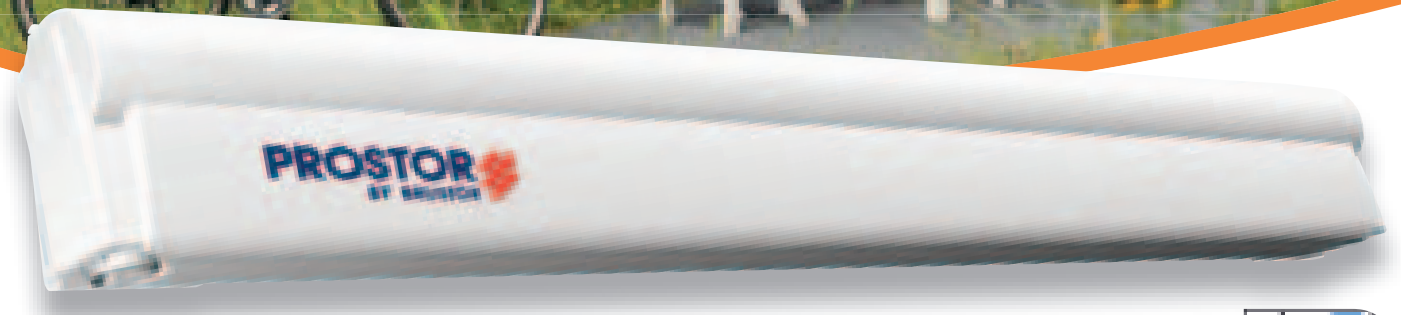

Wall mounting

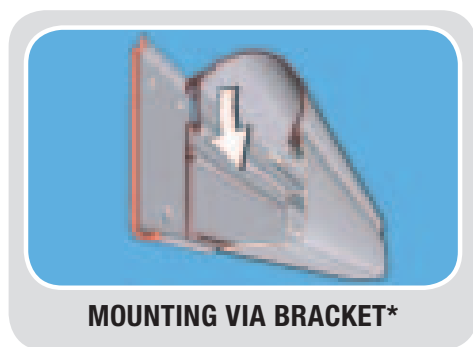

* Flat bracket supplied as standard.
For specific brackets see page 19.

Note: the brackets must be installed behind the end caps.

Dimensions (ALWAYS state x, y, zz when ordering)

Item number	Length	Projection	Weight
45x-265-y-zz	2.65 m	2.50 m	17 kg
45x-300-y-zz	3.00 m	2.50 m	19.5 kg
45x-350-y-zz	3.50 m	2.50 m	22 kg
45x-400-y-zz	4.00 m	2.50 m	24.5 kg

x: Awning box: 0 = White
1 = Anodised

y: Operation: 0 = Manual

zz: Fabric number: 01 = Jamaica Green
02 = Aruba Blue
03 = Grey Waves
04 = Blue Waves



COMPACT DIMENSIONS

The Prostor 450 is the most compact and lightest wall awning in the market, without decreasing the high quality requirements of Prostor.



NEW ARM AND SUPPORT LEG

The support legs are neatly stored in the lead rail of the awning. They can be easily released with the spring lock.



ALUMINUM END CAP

Like other Prostor awnings, the gearing is protected by a lacquered aluminium end cap. This end cap makes the awning even more impact and shock-proof.



ARM FIXED TO END CAP

The retractable arms are fixed to the robust aluminium end caps, therefore the dimensions of the awning are so compact. The mounting brackets must be placed behind this end cap.



IDEAL FOR CARAVANS AND VANS

The Prostor 450 offers a projection of 2.5m (instead of 2m) for the smallest awning length (2.65m). Its compact dimensions, light weight and this extra shade make the Prostor 450 the ideal awning for caravans and vans.



**100% ALU
END CAPS**



Wall mounting

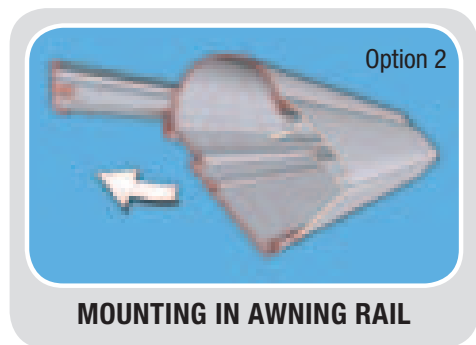
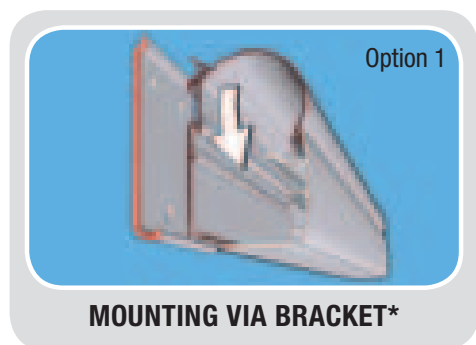

* Flat bracket supplied as standard.
For specific brackets and rails see page 19.

Dimensions (ALWAYS state x, y, zz when ordering)

Item number	Length	Projection	Weight
5x-150-y-zz	1.50 m	1.00 m	11 kg
5x-260-y-zz	2.60 m	2.00 m	21 kg
5x-300-y-zz	3.00 m	2.50 m	24 kg
5x-350-y-zz	3.50 m	2.50 m or 2.75 m	27 kg
5x-400-y-zz	4.00 m	2.50 m or 2.75 m	30 kg
5x-450-y-zz	4.50 m	2.50 m or 2.75 m	33 kg
5x-500-y-zz	5.00 m	2.50 m	36 kg
5x-550-y-zz	5.50 m	2.50 m	39 kg

x: Awning box: 0 = White
1 = Anodised
8 = Special coating (see pages 20-21)
9 = Cream RAL 1013

y: Operation: 0 = Manual
1 = Motor 230V
2 = Motor 230V - remote control
4 = Motor 12V

zz: Fabric number: 01 = Jamaica Green
02 = Aruba Blue
03 = Grey Waves
04 = Blue Waves
05 = White Sand
06 = Horizon Grey*
07 = Horizon Blue*





ROBUST BUT STILL COMPACT

The robust Prostor 500 is a top quality awning. This awning is very strong and stable. By the way, the Prostor 500 is the most compact awning for bigger lengths (4 m and more).



SAME AWNING BOX UP TO 5.50 M

The Prostor 500 has the same awning box for length up to 5.50 m. As a result the weight for larger awnings (from 4 m) decreases significantly.



MOTOR WITH MANUAL OVERRIDE

The motor (220V or 12V) is fully integrated in the roller tube and the emergency manual operation is a standard accessory. The motor can be operated by remote control (230V) or switch (12V or 230V). More information on page 27.



AUTOMATIC TWISTING FRONT PROFILE

This innovation ensures the front profile slides in and out smoothly. In other words, the awning opens and closes silently.



MORE SHADE

The standard projection is 2.50 m. Optionally, you can have a projection of 2.75 m for awning lengths of 3.5 m; 4 m and 4.5 m. Only available in fabric colour 06 and 07.



TELESCOPIC HAND CRANK

You can operate the ultra rapid and flexible gear with the extending hand crank. The crank can be easily stored with the 2 supplied clips.



END CAPS IN PLASTIC

NEW



The Prostor 550 has the same features as the Prostor 500, except:



PLASTIC END CAPS

The aluminium end caps with integrated locking device is replaced with plastic end caps, the standard in the market.

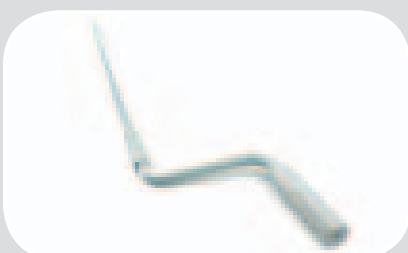

FIX CRANK

You can always operate the gear of the awning with this handy fix crank (not telescopic).

Dimensions (ALWAYS state x, y, zz when ordering)

Item number	Length	Projection	Weight
55x-300-y-zz	3.00 m	2.50 m	23 kg
55x-350-y-zz	3.50 m	2.50 m	26 kg
55x-400-y-zz	4.00 m	2.50 m	29 kg
55x-450-y-zz	4.50 m	2.50 m	32 kg

x: Awning box: 0 = White
1 = Anodised

y: Operation: 0 = Manual

zz: Fabric number: 01 = Jamaica Green
02 = Aruba Blue
03 = Grey Waves
04 = Blue Waves



DIFFERENT POSITIONS

The manual roller blind can easily be positioned at any height.

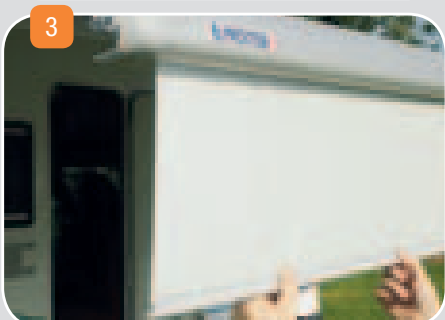

Dimensions (ALWAYS state x, y, zz when ordering)

Item number	Length	Projection	Weight
75x-300-y-zz	3.00 m	2.50 m	26 kg
75x-350-y-zz	3.50 m	2.50 m	30 kg
75x-400-y-zz	4.00 m	2.50 m	33 kg

x: Awning box: 0 = White
1 = Anodised
8 = Special coating (see pages 20-21)

y: Operation: 0 = Manual
1 = Motor 230V
2 = Motor 230V - remote control
4 = Motor 12V

zz: Fabric number: 01 = Jamaica Green
02 = Aruba Blue
03 = Grey Waves
04 = Blue Waves
05 = White Sand
06 = Horizon Grey*
07 = Horizon Blue*





Wall mounting

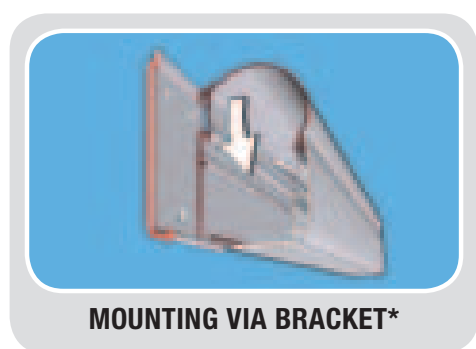

* Flat bracket supplied as standard.
For specific brackets and rails see page 19.

Dimensions (ALWAYS state x, y, zz when ordering)

Item number	Length	Projection	Weight
8x-400-y-zz	4.00 m	2.75 m	43 kg
8x-450-y-zz	4.50 m	2.75 m	46 kg
8x-500-y-zz	5.00 m	2.75 m	49 kg
8x-550-y-zz	5.50 m	2.75 m	53 kg
8x-600-y-zz	6.00 m	2.75 m	57 kg

x: Awning box: 0 = White
8 = Special coating
(see pages 20-21)

zz: Fabric number: 06 = Horizon Grey*
07 = Horizon Blue*
08 = Acrylic fabric



y: Operation: 0 = Manual
1 = Motor 230V
2 = Motor 230V - remote control
3 = Motor 230V - remote control - LED



STRONGEST AWNING IN THE MARKET

The Prostor 802 is by far the most robust awning in the market. The end caps are not made out of plastic, but out of 100% corrosion resistant powder coated aluminium.

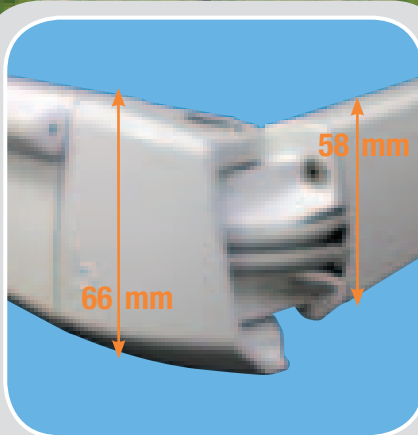

ROBUST RETRACTABLE ARMS

The twin steel cables in the solid retractable arms (66 mm high) provide perfect fabric tension.



SELF-SUPPORTING

The tensile force of the retractable arms is extra high. The Prostor 802 is therefore better wind-resistant and can be used with or without support legs (depending on the strength of the vehicle wall).



ACRYLIC FABRIC

Besides PVC fabric, the awning is also available in top quality acrylic fabric. This solution-died fabric keeps its colour for the life of your fabric. It has also been treated to resist dirt and water.



PROJECTION 2.75 M

More shadow means more joy. The Prostor 802 has a standard projection of 2.75 m.

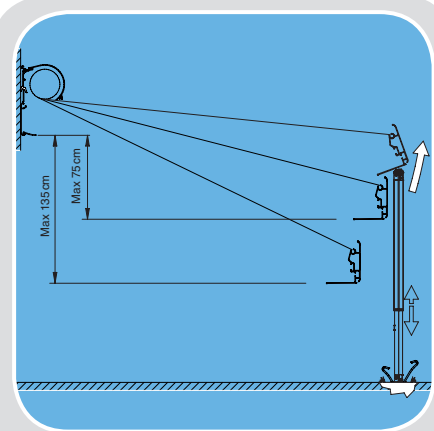

ADJUSTABLE INCLINATION

The inclination of the awning can easily be adjusted. The free-standing front profile falls between 0.75 m and 1.35 m with a projection of 2.75 m.



**PROSTOR 802 +
A BUILT-IN ROLLER BLIND**

The Prostor 900 has the same features as the Prostor 802 (see pages 16-17) but has in addition a roller blind incorporated in the front profile. The roller blind can be easily positioned at any height.

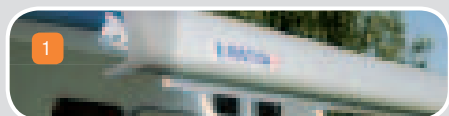

Dimensions (ALWAYS state x, y, zz when ordering)

Item number	Length	Projection	Weight
9x-400-y-zz	4.00 m	2.75 m	48 kg
9x-450-y-zz	4.50 m	2.75 m	51 kg
9x-500-y-zz	5.00 m	2.75 m	54 kg
9x-550-y-zz	5.50 m	2.75 m	58 kg
9x-600-y-zz	6.00 m	2.75 m	62 kg

x: Awning box: 0 = White
8 = Special coating
(see pages 20-21)

zz: Fabric number: 06 = Horizon Grey*
07 = Horizon Blue*
08 = Acrylic fabric



y: Operation: 0 = Manual
1 = Motor 230V
2 = Motor 230V - remote control
3 = Motor 230V - remote control - LED

Prostor 450, 500, 550, 750, 802 & 900 - wall mounting

FLAT BRACKET

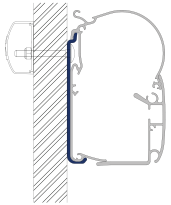

4100016

EURA MOBIL

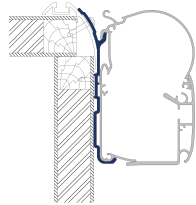

4100018

HYMERCAMP

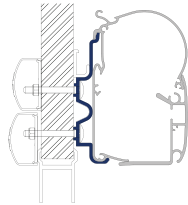

4100019

HYMER VAN / B2

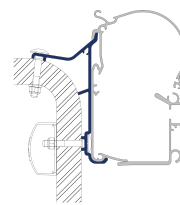

4100020

LAIKA ECOVIP

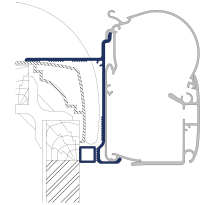

4100021

RAPIDO 7 - 8 - 9

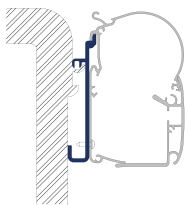

4100022

BÜRSTNER SQUARE HOBBY

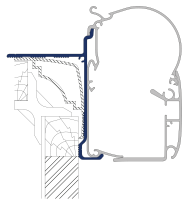

4100023

KNAUS C-LINER

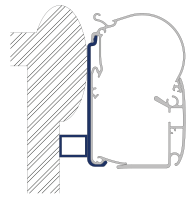

4100024

DETHLEFFS GLOBEBUS

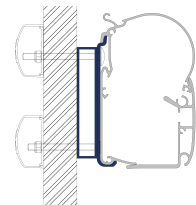

4100025

CHAUSSON - ARCA

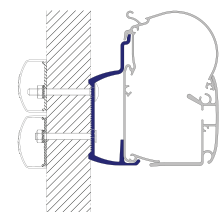

4100026

LAIKA REXOSLINE

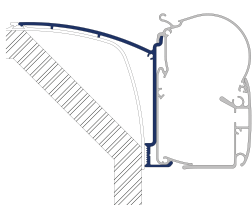

4100030

BÜRSTNER ROUND

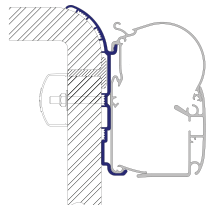

4100043

LUXE CARAVAN RAIL

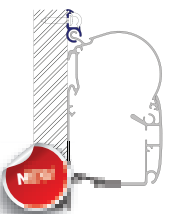

4100046

DUCATO H2 ROOFRAIL

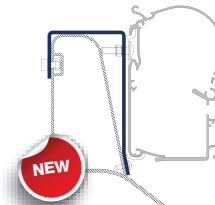

4100047

DUCATO H3 LE VOYAGEUR

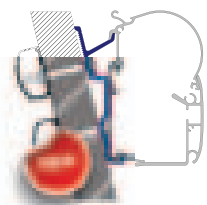

4100048

Prostor 350 & 600 - roof mounting

HYMER SX

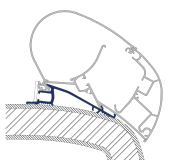

4100028

LAIKA KREOS 05

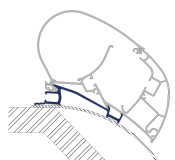

4100029

DUCATO-JUMPER-BOXER

One part

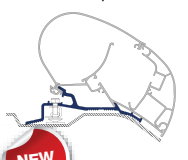

4100033

ESTEREL

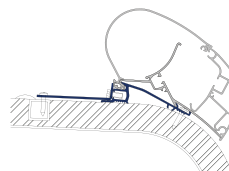

4100034

CARAVAN

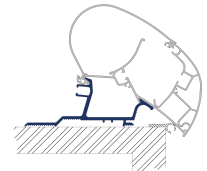

4100037

SPRINTER - CRAFTER

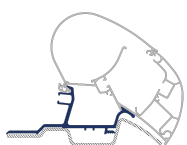

4100038

MASTER - MOVANO < 2011



4100044

LMC / TEC

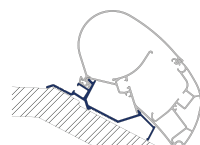

4100045

MASTER - MOVANO > 2011

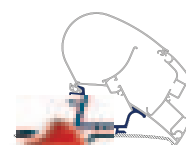

4100037

The brackets mentioned above can also be used on other types of vehicles. Please contact your dealer for more information.

Fabric colours

The **polyester fabric** with a PVC coating is from the highest quality. The fabric is colour resistant, waterproof, washable, rot-proof and can be rolled up when damp. Moreover the Prostor fabric is made of one piece (without welding seam) and so the fabric is printed from top to bottom.

The PVC fabric consists of 5 layers:

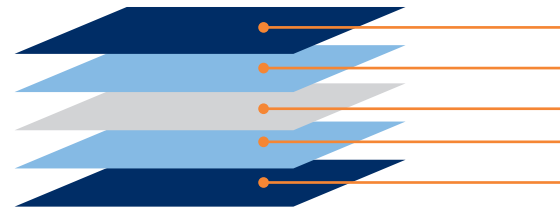

	PVC				
	01 Jamaica Green	02 Aruba Blue	03 Grey Waves	04 Blue Waves	05 White Sand
					 Detail structure
350	lb	lb	lb	lb	
450	lb	lb	lb	lb	
500	lb	lb	lb	lb	lb
550	lb	lb	lb	lb	
600	lb	lb	lb	lb	lb
750	lb	lb	lb	lb	lb
802					
900					

Box colours



	STANDARD		SPECIAL		
	White	Anodised	Bürstner Champagne	Bürstner Opaal	Pilote/Notin Cream (RAL 1013)
350	lb	lb			
450	lb	lb			
500	lb	lb	lb	lb	lb
550	lb	lb			
600	lb	lb			
750	lb	lb			
802	lb				
900	lb				

- Protective PVC coating
- Vinyl with colour pattern
- Polyester tissue of the highest quality
- Vinyl with colour pattern
- Protective PVC coating

The high quality **acrylic fabric** is solution died and keeps its colour for the life of your awning. It has also been treated to resist dirt, water and mould and algae growth. The fabric has vertical welding seams.

06 Horizon Grey NEW	07 Horizon Blue NEW
b	b
b	b
b	b
b	b
b	b
b	b

ACRYLIC*		
Code 6088	Code 7133	Code 8908
b	b	b
b	b	b

* Other acrylic fabric colours (uni or striped) possible. Please contact your dealer for more information.

Anthracite (RAL 7021)	Black (RAL 9005)	Other RAL colours *
		
b		b
	b	b
		b
		b
		b

* Other box colours possible. Please contact your dealer for more information.



DETERMINE YOUR OWN AWNING COLOUR

Thanks to the new powder coating installation, Prostor is able to produce awnings taking into account your specific colour wishes. Each awning will even better match the vehicle or caravan. Due to this unique state-of-the-art technology all RAL colours can be offered against a surcharge.



Water- and windproof due to new clamping profile. Easy and fast installation.

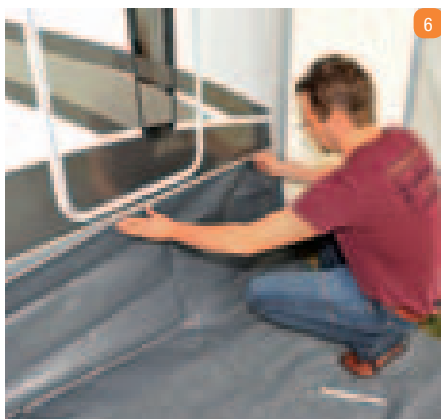
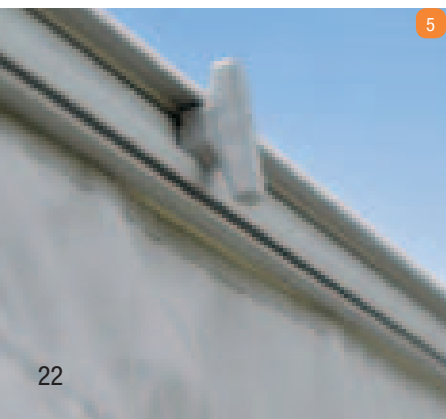
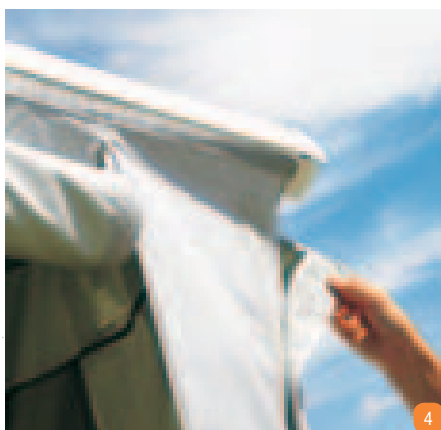
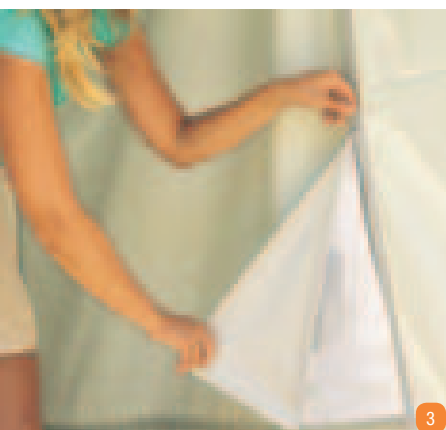

1. Mosquito screen

All windows are standard supplied with a mosquito screen.

2. Darkening

The roll up darkening at the inside provides more privacy and comfort.

3. Zipper

The windows and the darkening can easily be opened and closed thanks to the zipper.

4. Hook and loop fastener

The side panels can quickly be fastened to the front panel by means of Velcro.

5. Pivoting clamping profile

The Prostor Camp Room is equipped with a new patented clamping profile (see page 23).

6. Skirt

You can make the Camp Room completely water- and windproof by covering the underside of the vehicle with the standard supplied skirt.

Dimensions

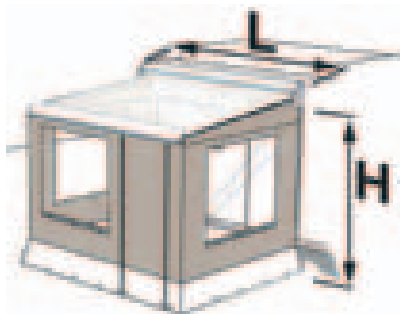

	CAMPROOM Front	Length L
PROSTOR 350, 450, 500, 550 & 600	5400113	2.60 m
	5400114	3.00 m
	5400116	3.50 m
	5400117	3.75 m
	5400118	4.00 m
	5400119	4.50 m
	5400120	5.00 m
	5400121	5.50 m
	5400186	6.00 m

	CAMPROOM Side	Height H	Projection
PROSTOR 450, 500 & 550	5400103	Small	2.00 - 2.29 m
	5400104	Small	2.00 - 2.29 m
	5400106	Medium	2.30 - 2.59 m
	5400109	Large	2.60 - 2.89 m
	5400111	X-Large	2.90 - 3.20 m
PROSTOR 350 & 600	5400142	Ducato H2	2.30 - 2.59 m
	5400140	Medium	2.30 - 2.59 m
	5400141	Large	2.60 - 2.89 m

HEIGHT FRONT PROFILE: 1.80 - 2.10 m

Pivoting clamping profile

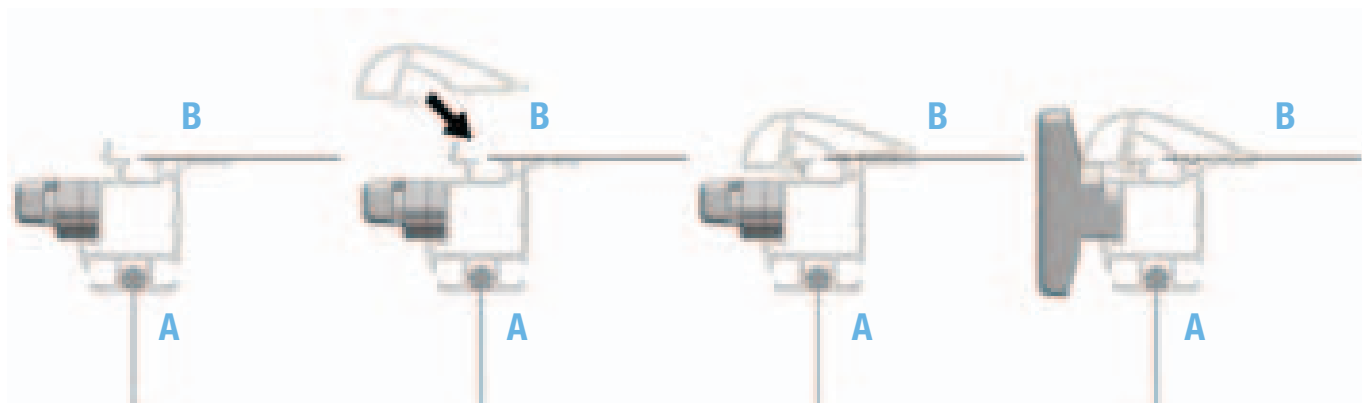
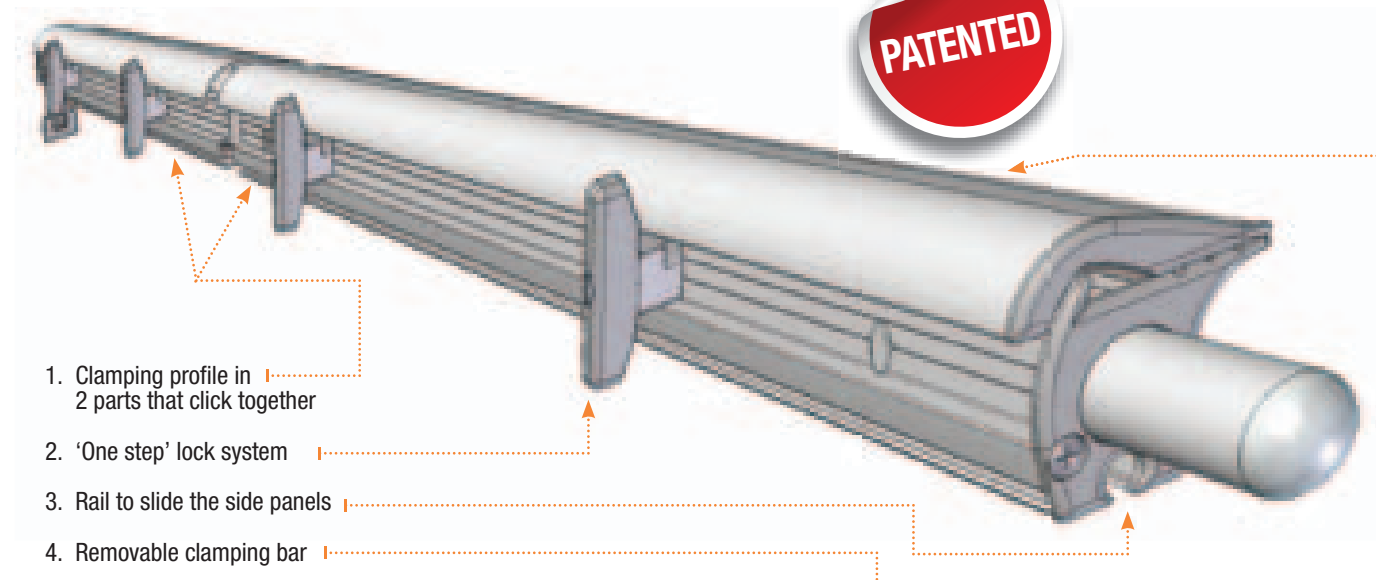

Step 1

Slide the side panel with string (A) in the clamping profile. Then put the awning fabric (B) on the profile.

Step 2

Pivot the clamping bar with the clamping profile. Lock is in a horizontal position.

Step 3

Turn the lock a quarter of a turn, so that the awning fabric is well sealed. Lock is in a vertical position.



Simple and very quick installation

Scan this QR code and watch the installation video on your smartphone, or visit www.prostor.be



Step 1: Fasten the clamping profiles



Click the clamping profiles of the side panels together.

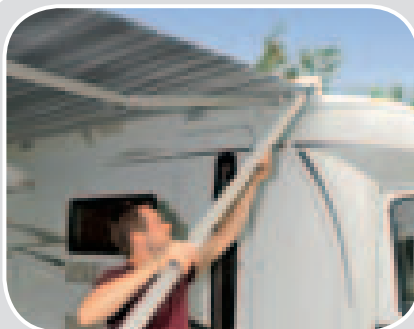

Thanks to a built-in spring, you can easily tighten the clamping profile between the awning box and the front profile.

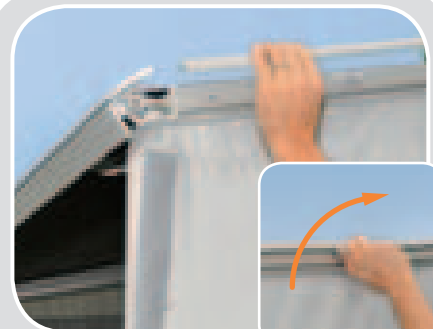

The awning fabric lays automatically on the clamping profile. Put the clamping bar on the clamping profile and turn the lock **just a quarter of a turn**.

Step 2: Attach the side panels

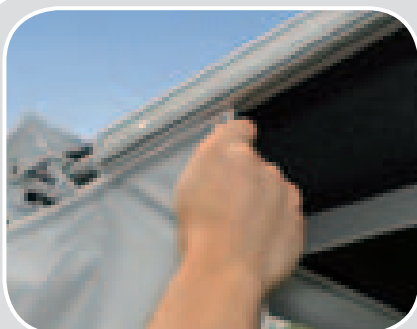

Slide the side panel with string in the rail of the clamping profile.

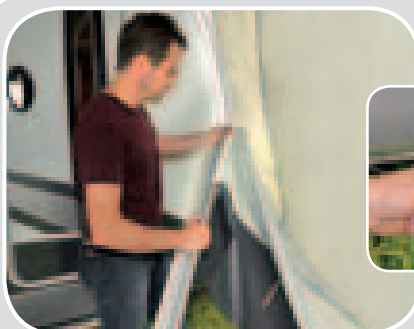

Click the mast profiles together and slide in the string of the side panel. The height can easily be adjusted. Press the rubber flaps against the side of the vehicle.

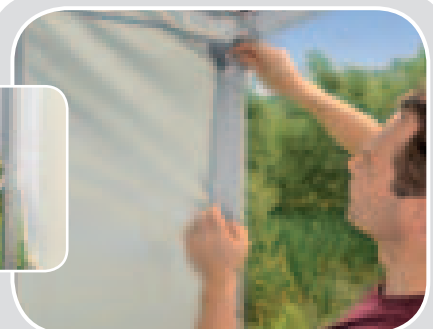

Fasten the side panel to the support leg by means of Velcro.

Step 3: Tighten the diagonal profiles

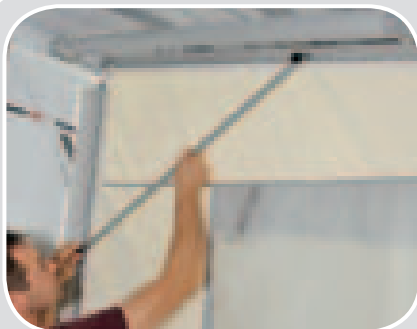

Screw the diagonal profiles in the mast and clamping profiles.

Step 4: Attach the front panel

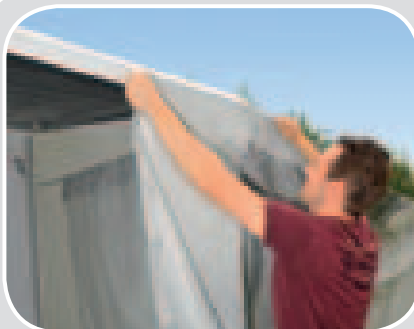

Slide the front panel with string in the rail of the front profile.

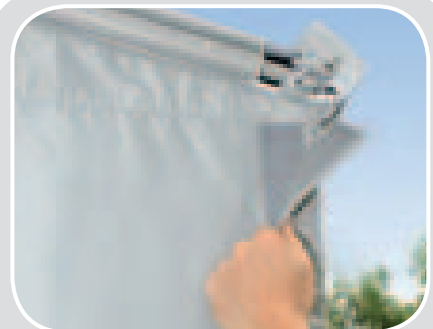

Fasten the front panel easily with the sides by means of Velcro.

SUN PROTECTOR - front

SUN PROTECTOR - side



RAIN PROTECTOR - front

RAIN PROTECTOR - side

Sun Protector

The Prostor Sun Protector is a see-through, light transparent screen fabric in cream colour, which keeps the heat out. The front and the side panels are available in different sizes. The side panel can be used both right and left.

Rain Protector

The Prostor Rain Protector is a grey, non-transparent PVC fabric which is water- and windproof. The front and the side panels are available in different sizes. The side panels have a built-in window. The side panel can be used both right and left.

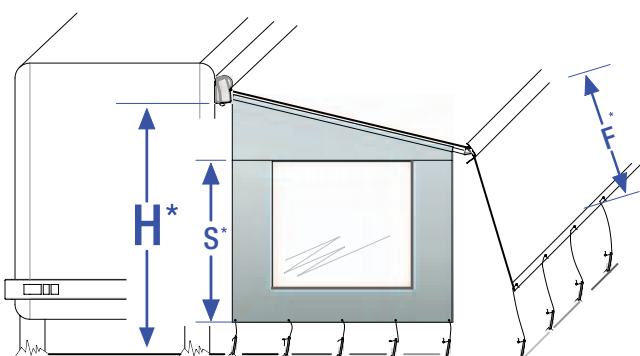

Dimensions

	SUN-Front	RAIN-Front	Length	F *
PROSTOR 350, 450, 500, 550, 600 & 802	4000031-260	4000101-260	2.40 m	1.45 m
	4000031-300	4000101-300	2.80 m	1.45 m
	4000031-350	4000101-350	3.30 m	1.45 m
	4000031-375	4000101-375	3.55 m	1.45 m
	4000031-400	4000101-400	3.80 m	1.45 m
	4000031-450	4000101-450	4.30 m	1.45 m
	4000031-500	4000101-500	4.80 m	1.45 m
	4000031-550	4000101-550	5.30 m	1.45 m
4000031-600	4000101-600	5.80 m	1.45 m	

	SUN-Side	S *	RAIN-Side	S *	H *
PROSTOR 350, 450, 500, 550, 600 & 750	4000032-01	1.45 m	4000102-01	1.65 m	S
	4000032-02	1.45 m	4000102-02	1.65 m	M
	4000032-03	1.45 m	4000102-03	1.65 m	L
	4000032-06	1.45 m	4100102-06	1.65 m	XL

H*: S = (2.00 m - 2.29 m) M = (2.30 m - 2.59 m) L = (2.60 m - 2.89 m) XL = (2.90 m - 3.20 m)



DAY

NIGHT



**BUILT-IN LED:
PROSTOR 500, 550 & 600**



**BUILT-ON LED:
PROSTOR 802 & 900**

The Prostor LED-light (12V) is a unique patented lighting system that lights up the space under the awning by nightfall. This Power LED light, in the middle of the awning, not only provides a cosy atmosphere but it can also (for example) be used to read a book. This 12V lighting system offers a lot of advantages: the casing of these lights never gets hot which prevents any risk of burning the fabric. The power LED light is a long-life system with a very low energy consumption and is waterproof. While closing the awning, the LED lights disappear together with the retractable arms in the awning box. All the wiring is hidden in the retractable arms and awning box. The Prostor LED light is an accessory and can be easily built on afterwards.



LED STRIP

You can also opt to fix a LED light strip on the underside of the awning box. This LED strip can directly be glued on the wall or fixed by an aluminium profile.



WITH ALUMINIUM PROFILE



WITHOUT ALUMINIUM PROFILE

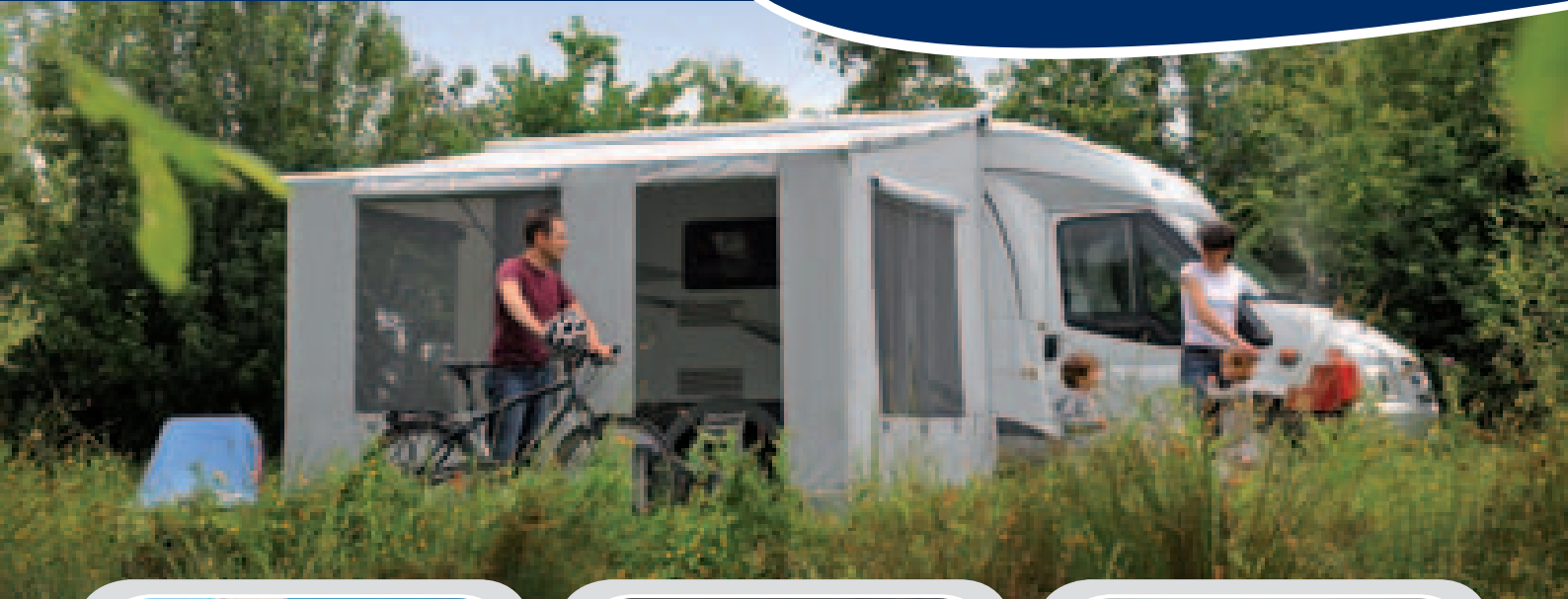

TENSION RAFTER

The tension rafter keeps the fabric tight. Supplied as standard for awnings of 4 m and more. There are 2 versions: 2.50 m and 2.75 m.



FOAM BAND

Close the space between the vehicle and the Prostor 350 or Prostor 600 roof awning. Width = 30 mm, Length = 4000 mm, Thickness = 25 mm.



SEALING JOINT

Ensure waterproofing between the wall of the vehicle and the Prostor 500, 550, 750, 802 or 900 awning. Available in different lengths (3 m, 3.50 m, 4 m and 30 m) and widths (Small = 50 mm, Large = 75 mm.)

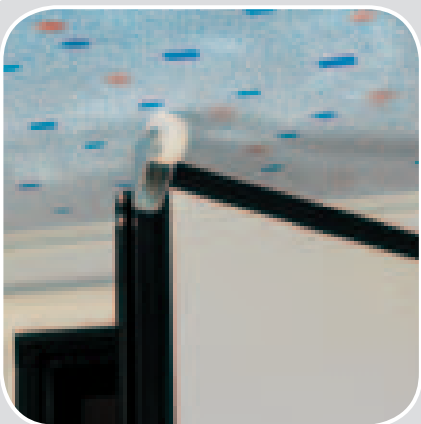

PROTECTION WHEEL

Prevents damage to the awning fabric when opening the door.

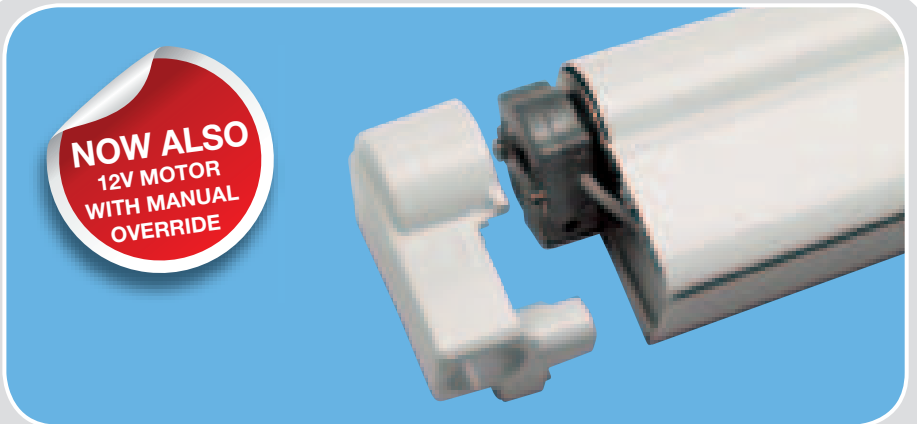

MOTOR

Various awnings can also be equipped with an integrated 230V or 12V motor without enlarging the awning. The motor can be operated via a remote control (230V) or a switch (12V or 230V); please state your preference when ordering. Both motors have an integrated manual override for emergency operation. A manual awning cannot be installed retrospectively with a motor.

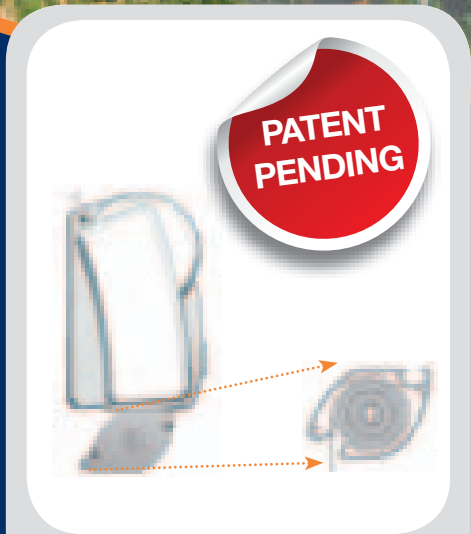

UNIQUE SYSTEM

A roller blind that can be easily fixed on the front profile of an awning (patented system). It fits on all existing wall awnings with an L-shaped front profile.



SLIM AND BEAUTIFUL DESIGN

Due to its slim design, the roller blind can be subtly mounted on each awning box. Possible lengths: 2.60 m; 3 m; 3.50 m and 4 m. Available in white or grey.



DIFFERENT POSITIONS

The manual roller blind can easily be positioned at any height. It can be automatically rolled up. See page 18.



BRUSTOR nv
Muizelstraat 20 - 8560 Gullegem - BELGIUM
Tel.: +32 56 26 56 56 - Fax: +32 56 20 01 35
info@prostor.be
www.prostor.be

YOUR PROSTOR DEALER: